

# Pre-Installation Instructions

Check if the accessories fit your toilet dimension and then install bidet seat.

User's Manual and warranty		Remote control + batteries	
Installation plate		Remote control holder	
Junction valve		Wall mount + screws	
Expandable screw set		Unit mount + screws	
Connector hose			

- After installation work is completed, do not connect the power or water.
- This is the cause of many malfunctions. The unit connector is made of plastic so avoid using an inappropriate amount of torque when tightening it down to prevent the unit connector from becoming cracked.
- In order to full utilize all of the product functions, follow the installation instruction to ensure correct installation.

Note: This product is used with PF 1/2 toilets. If you wish to install this product on a non-PF 1/2 toilet and the connection method must be changed, ask a professional service technician from a reputable company to do the installation to prevent leakage problems.

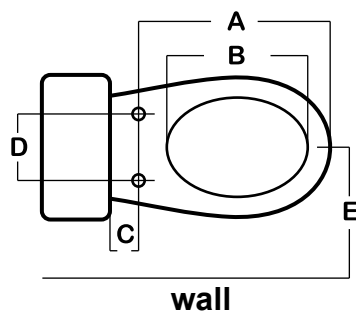

Bidet Seat	HI-5000 HI-7000	HI-5001 HI-7001
A	440mm	470mm
B	320mm	355mm
C	55 mm and above	
D	140~170mm	
E	270 mm and above to wall	

# Installation Instructions

**1** Remove the original toilet lid

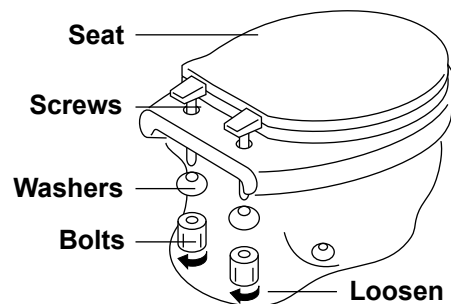

**2** Check the installation position  
Place the unit temporarily. After checking if the front edge of the unit lines up with the front edge of the toilet, mark a guide line at the back end of the unit.

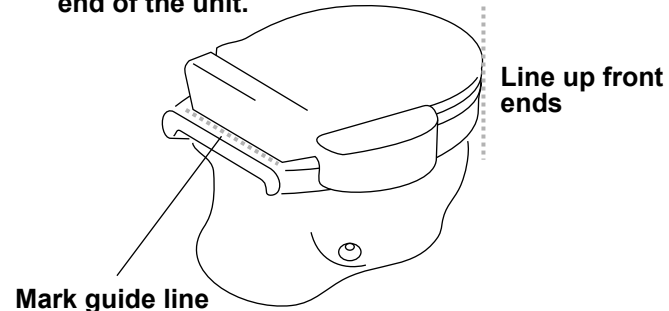

# Installation Instruction

**3** Install the installation plate on the toilet so the back end of the installation plate lines up with the guide line and then fasten down with screw sets.

(screw together the expansion tubes and bolts and then insert into toilet installation holes)

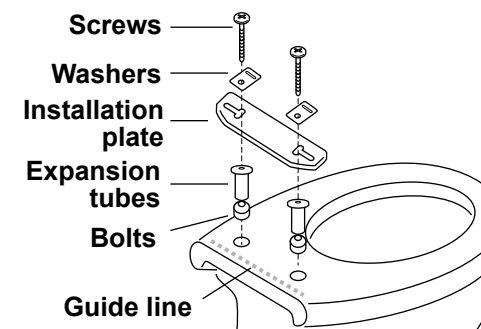

**4** Three types of installation methods to choose from

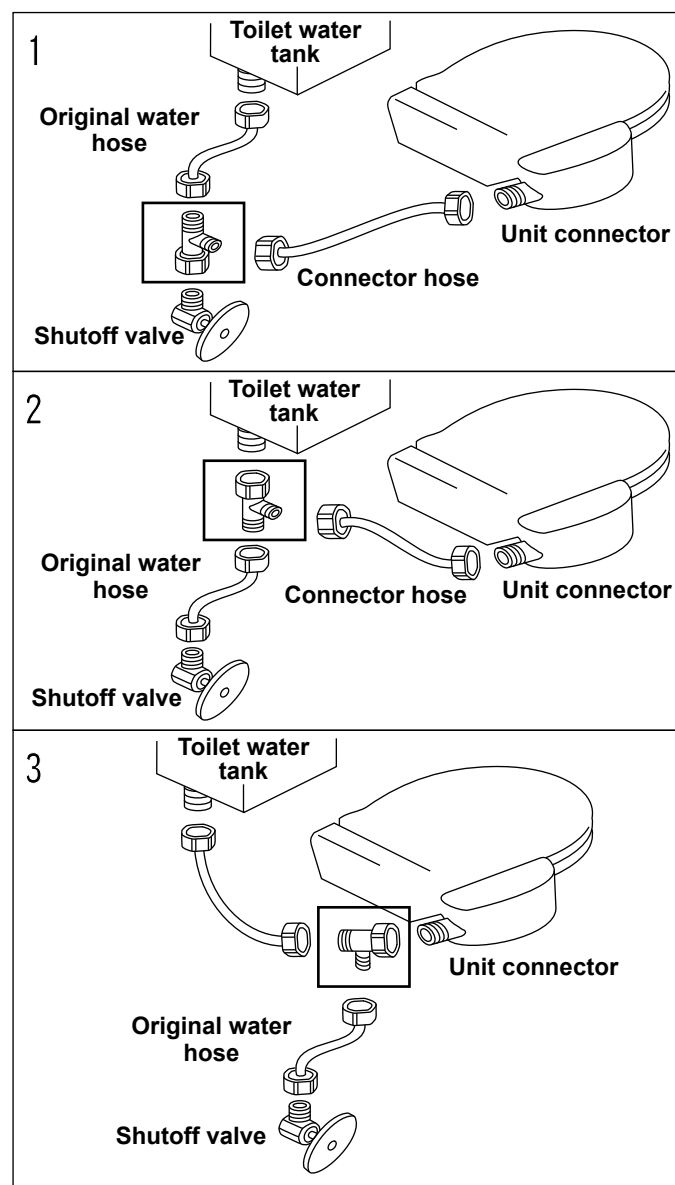

**5** When you hear a “kah” sound, the plate is installed in place.

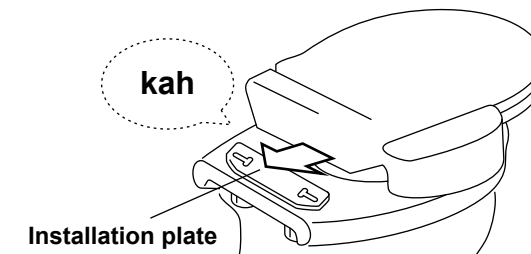

Press the disassembly button when disassembling the unit and pull the unit up and forward to remove the unit.

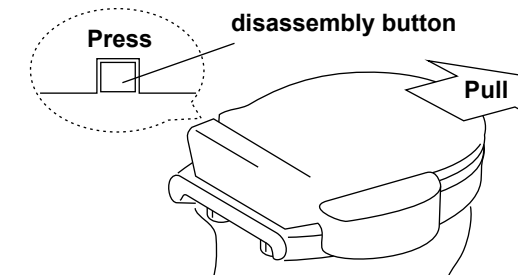

**6** Test use

- Plug the power cord into the socket with the rated voltage
- After installation, follow the correct use methods in the instruction books during trial use



**Warning**

- Do not plug into power source before completing installation.
- Do not use an inappropriate amount of torque when tightening down the hoses because the unit connector is made of plastic to prevent the unit connector from becoming damaged.

# Inspection and Maintenance

Malfunction	Diagnostic Procedure	Troubleshooting
Water output flow low / water supply interrupted / nozzle does not function normally	1. Foreign object stuck to the nozzle extension rod exterior. 2. Filter unit clogged.	1. Clean nozzle extension rod exterior. 2. Clean filter unit.
Rinse key does not work when pressed	Seat device failure to sense	Make sure forward movement can be sensed. Do not sit too far forward.
Auto shutoff during rinsing	1. Rinse for five or more minutes. 2. Turn off power.	1. Press rinse key again. 2. Activate electrical leak detection. Reconnect power.
Warm seat temperature too low	Heating time too short	Frequently maintain seat temperature setting status
Warm seat temperature too low	1. Heating time too short 2. Continuous rinse time too long	1. Frequently maintain water temperature setting status 2. Try to complete rinsing before water cools down
Warm air function defect 7000 model	1. Warm air temperature too high or too low. 2. Warm air stops midway during operation. 3. Does not function.	1. Press warm air key to adjust. 2. Press warm air key again. 3. Make sure the backward movement is sensed.
Deodorizer function not effective 7000 model	1. Dust stuck to deodorizer. 2. Foreign object stuck to the deodorizer intake.	1. Clean deodorizer 2. Clean deodorizer intake
Poor or weak remote controller reception displayed	Lamp does not display or power lamp flickers when remote controlled pressed.	Replace batteries
Other (includes the above conditions that cannot be diagnosed or troubleshot using these instructions)	Contact distributor or service personnel by phone.	Ask professional technician or authorized dealer for part repair

## Things that you should know

- ⊙ When the environmental temperature is higher than 35 degrees, use the mid or high temperature setting.
- ⊙ A portion of the water will flow out from the side the nozzle during rinsing. This is not a malfunction. It was designed to do so.
- ⊙ There will not sufficient water flow even at the maximum flushing strength setting if the tap water pressure is lower than 1.3kgf/cm<sup>2</sup>. As long as there is adequate water flow, insufficient water flow will not occur even when if the toilet cabinet is filling or other water faucets are running and the tap water pressure drops below 1.3kgf/cm<sup>2</sup>
- ⊙ First check if the power is the correct specification before power connection.
- ⊙ The unit automatically shuts off if flushing or warm air is used continuously for 5 minutes. Press the rinse or warm air key again for more rinsing and warm air.
- ⊙ If the power to the unit suddenly shuts off under normal use conditions, the electrical leak detector has probably activated. Immediate stop use and unplug the power. Then plug it back in to reconnect to restart.

# Bidet Seat

## Use and Installation Instructions

HI-5000 / HI-5001  
HI-7000 / HI-7001



**Includes built-in electrical leak shutoff device**





- ⊙ Thank you for purchasing the bidet seat
- ⊙ Read these instructions carefully before use to learn how to correctly use and properly maintain the unit.
- ⊙ Make sure the retailer records the purchase date and name of the retailer on the warranty to protect your rights.







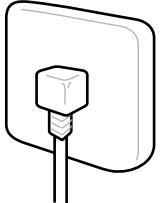

# Safety Instructions

## Please follow the instructions below.

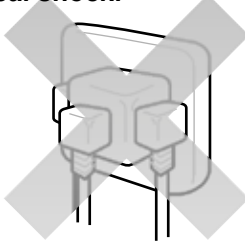
Read the installation instructions carefully and use in a correct manner.  
Make sure to closely follow the all of the safety-related instructions.

### ◎ The signs and their meanings:

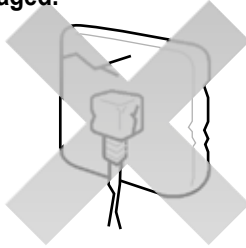
 <b>Warning</b>	Improper use could result in personal injury	 <b>Prohibited</b>	Prohibited means the action is not allowed.
 <b>Caution</b>	Improper use can result in personal injury or property damage.	 <b>Mandatory</b>	Mandatory means that it must be done.

 <b>Warning</b>	
<ul style="list-style-type: none"> <li>● <b>Stop unit operation if a malfunction occurs (such as a burning odor) and unplug the power.</b></li> <li>◎ If a fire or electrical shock occurs due to overheating during continued used after a malfunction appears, promptly contact the retailer or a company authorized service station.</li> </ul>	<ul style="list-style-type: none"> <li>● <b>Make sure the plug is inserted correctly. An improperly inserted plug can cause short circuits or overheating which may cause fire or electrical shock.</b></li> </ul> 
 <b>Mandatory</b>	 <b>Mandatory</b>
<ul style="list-style-type: none"> <li>● <b>Make sure the plug is inserted correctly. An improperly inserted plug can cause short circuits or overheating which may cause fire or electrical shock.</b></li> </ul> 	<ul style="list-style-type: none"> <li>● <b>Nobody except for company technicians should attempt to disassemble, repair and modify this unit because of the fire hazard. Improper use may also cause fire hazards, electrical shock or injury.</b></li> <li>◎ If repairs are needed, contact the retailer that you purchased the unit from or a company authorized service station.</li> </ul> 
 <b>Prohibited</b>	 <b>Disassembly prohibited</b>
<ul style="list-style-type: none"> <li>● <b>Do not drip water on the unit. It could cause electrical shocks, short circuits and fire hazard to occur.</b></li> </ul> 	<ul style="list-style-type: none"> <li>● <b>Do not use a damaged power cord or extension cord. Do not use a modified power cord or place heavy objects on it to prevent the cord from getting ripped or damaged.</b></li> </ul> 
 <b>Don't drip water on unit</b>	 <b>Prohibited</b>

# Deodorizer Box Cleaning

1. Remove the deodorizer box from the side of the unit
2. Use brush to clean the deodorizer intake under the unit.
3. Clean off the dust stuck to the deodorizer with a vacuum cleaner
4. Follow these above steps in reverse after cleaning to put back in place.

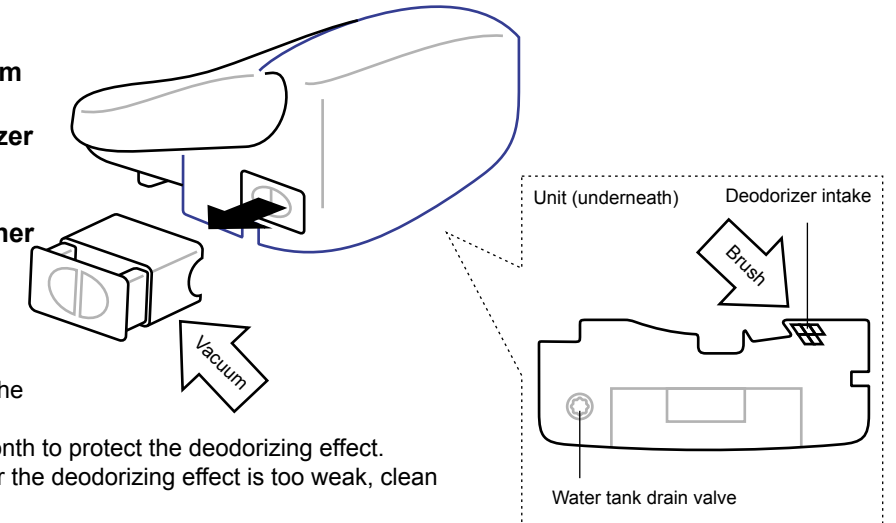

- \* Do not rinse with water. It will reduce the deodorizing effect.
- \* Regularly clean and maintain each month to protect the deodorizing effect.
- \* If the deodorizer is used for too long or the deodorizing effect is too weak, clean and maintain.

# Water Tank Cleaning

1. Open the drain valve to let the old water flow out of the water tank. (see Fig above)
2. Close the drain valve and press down on the right side on the seat with your hand while simultaneously pressing on the rinse button. At this time, water will enter the water tank and water will continually flow out of the nozzle to clean out the water tank.

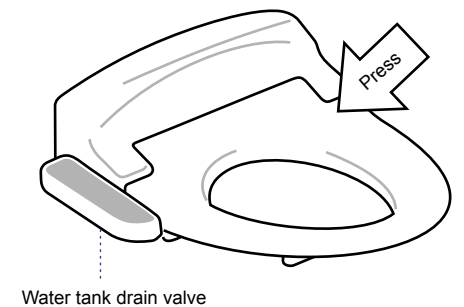

# Product Specification

Specification		Model Name	
		HI-5000 / HI-5001	HI-7000 / HI-7001
Power Supply		AC100V-120V 50/60Hz	AC220V-240V 50/60Hz
Water supply prassure		10 psi ~ 70 psi	
Average daily power consumption		about 1500Wh	
Heated Seat		Room temp./ 『low』 :about 35℃/ 『mid』 : about 37.5℃/ 『high』 :about 40℃ 35℃=95°F 37.5℃=99.5°F 40℃=104°F	
Seat, Lid		Soft colsing damper	
Water Feature	Max flow	about one liter per minute	
	temperature	Room temp./ 『low』 :about 35℃/ 『mid』 :about 37.5℃/ 『high』 :about 40℃ 35℃=95°F 37.5℃=99.5°F 40℃=104°F	
Internal electrical leak detection		Rated operating current 15mA	
Power cord length		1.5M or 2.0M (depending on region)	
Dimensions (HxWxD)		18cm x 48cm x 48cm (5000 / 7000 model) / 51cm (5001 / 7001 model)	
Gross weight		(5000 model) approx. 6.0 kg / (7000 model) approx. 6.4 kg	
Dryer 7000 model	Dryer temp.	Warm air temp 3 stage temperature control Approx. 40℃~70℃	
	Power consamption	280W~400W	370W~435W

## Toilet lid cleaning

1. Lift up the lid and slide the edge of the rim outward

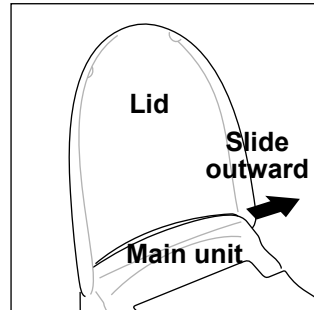

2. Lift up the right side of the lid

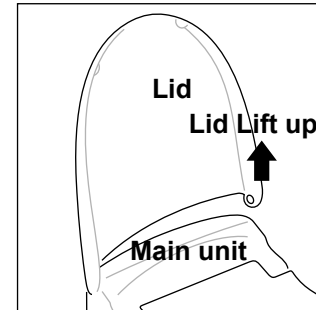

3. Move the lid to the left so it can be taken off and cleaned.

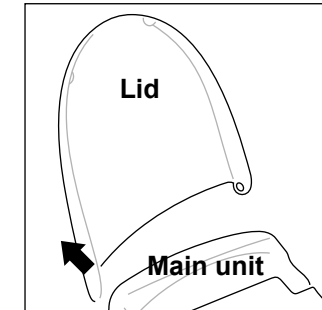

4. After cleaning is done, follow the above steps in reverse to put back in place.

## Toilet Seat Cleaning

1. After the seat is lifted up, slide the holder on the left side upward.

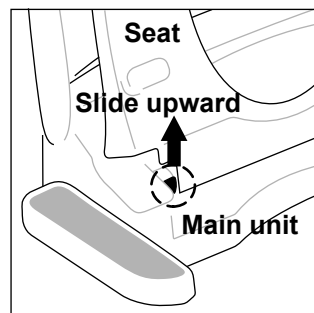

2. Lift up the left side of the seat

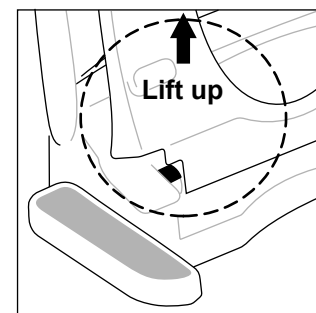

3. Move the seat to the left to pull out the seat for cleaning.

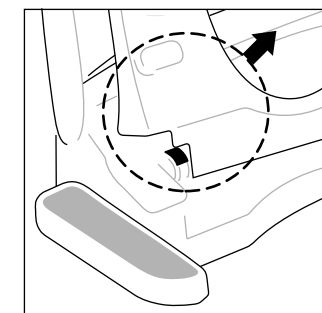

4. After cleaning is done, follow the above steps in reverse to put back in place.



**Warning**

Since there is a fixed corrugated pipe to protect the connector wire on the right side on the holder, the seat can be moved slightly out of the unit to allow cleaning. Do not forcibly pull out the corrugated pipe.

## Filter Module Cleaning

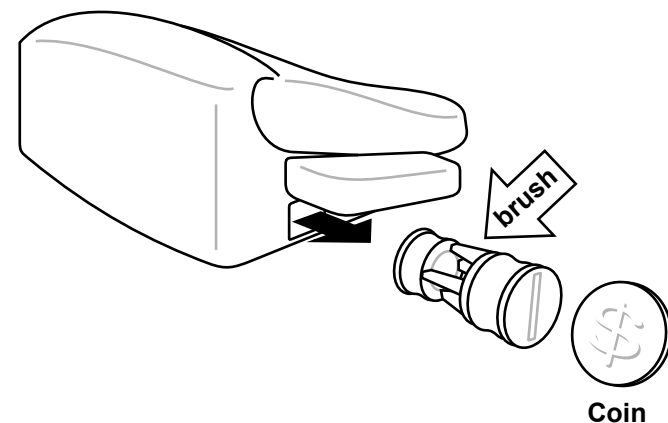

1. First close the tap water shutoff valve
2. Remove the decorative rubber from the side of the unit
3. Remove the filter module (use a coin or tool)
4. Use a brush to lightly clean the filter surface.
5. After cleaning, follow the above step in reverse to put back to place.

\* After filter cleaning, make sure the filter module is screwed tightly back into the unit.

## Safety Instructions

### Warning

● Do not use well water or industrial -use water

⊙ It could cause skin infections or other medical conditions

● Do not damage the power cable or plug

⊙ Do not damage or modify the power cable. Do not expose to high temperatures, twist, yank, crush under heavy weights or knot up.  
⊙ Using a damaged power cable could cause electrical shock, short circuits and fire hazards. Contact the retailer to find out how to repair power cables or plugs.

**Prohibited**

**Prohibited**

● It could cause an electrical shock.

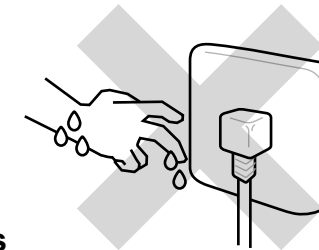

**Wet Hands Prohibited**

● Do not apply force, overflex or twist the water feed hose

⊙ It could leaks on the water feed hose

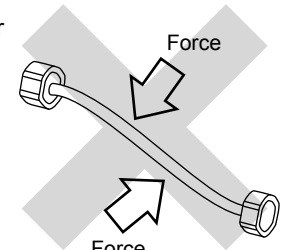

**Prohibited**

● Do not lean against the lid

⊙ It could cause the lid to crack or flip back.

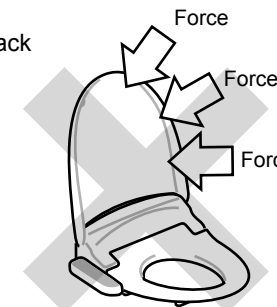

**Prohibited**

● Do not sit on top of the unit or strike the unit

⊙ A person could fall off or the unit could break.

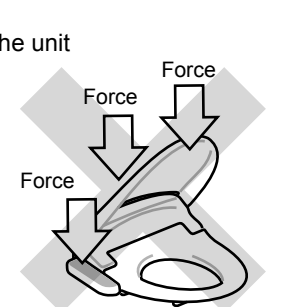

**Prohibited**

● Regarding low temperature burns and precautions:

- ⊙ Burns are commonly heat burns. Burns are caused by water, oil or a high temperature object coming into contact with the skin. Low temperature burns can even be caused by long-term skin exposure (varies depending on the person and conditions) to relatively low temperature (40 to 60 degrees) objects.
- ⊙ Regular burns only affect the surface of the skin but low temperature burns penetrate into the internal layers of the skin and cause red spots and blistering.

**Mandatory**

- ⊙ The following persons should adjust downward to low temperature and be checked frequently to see if any problems occur during use
  - Persons who are unable to adjust the unit to a suitable temperature such as children and the elderly.
  - Persons unable to call others for assistance such as the seriously ill and the handicapped.
  - Persons who are very fatigued, may fall asleep, have consumed alcohol or are taking medication (sleeping pills, cold medicines).
- ⊙ If red spots or blistering appear, immediately seek treatment from a doctor.

## Safety Instructions

### ! Mandatory

- This product is an electrical device. Do not place it where water can splash on it or in a very humid location. When using it in the bathroom, set up a ventilation fan or vent opening so good air flow is maintained in the bathroom.

⊙ Otherwise, there is a risk of fire hazard or electrical shock.

- The socket used for the electrical connection should be set up as follows:

- ⊙ There is a risk of fire hazard or electrical shock if the unit is not connected in the following manner.
  - Use a high sensitivity, fast circuit breaker for the socket circuit (rated current sensitivity of 15mA or below) or an insulating transformer (1.5 KVA and above, 3KVA and below) for electrical protection.
  - The socket must be installed at a location 0.8 m or higher and a reasonable distance away from the bathtub.
- ※ Contact your retailer or service personnel if the socket is not installed in this manner.

- A ground wire must be installed.

- ⊙ There is a risk of electric shock if there is an accidental electrical leak occurs with no ground wire installed.

**Note: The definition of grounding here is a ground resistor of 100Ω or below, the ground wire diameter for the control board must be 1.6mm or thicker copper wire.**

※ Contact your retailer or service personnel if no ground wire has been installed.

- Unplug the unit and drain the water out of the water tank when the unit will not be used for a long period of time.

- ⊙ Unused water stored in the unit will degrade over time and could cause skin infections or other medical problems if used (see the cleaning method on page 10).

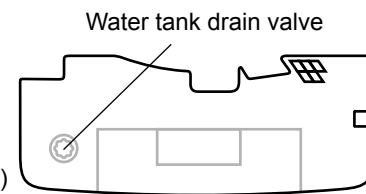

### ! Mandatory

## Use Instructions

### ⊘ Prohibited

**Never smoke or allow anything that produces sparks nearby**  
It could become a fire hazard

**Do not lift up the unit when holding the seat or lid with your hands**  
Personal injury could occur if the unit falls off.

**Do not use a nylon scouring pad or strong acid / base solvent to wipe the product**  
It could damage the product or cause it to malfunction

**Do not place the product in a location where it is exposed to direct sunlight**  
The product may become discolored or the seat temperature could become uneven.

## How to Use the Product Correctly

### Stop



Wipe the water drops off your posterior

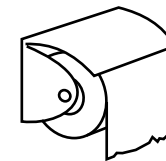

### Deluxe function

— Dryer —



Press dryer button



Press Dryer Temp. button

- ⊙ Press the dryer button to activate the dryer function
- ⊙ After pressing the dryer function, press the dryer temp button to adjust to a suitable temperature.
- ⊙ It will automatically stop after five minutes of drying. If you wish to continue use, press the dryer button again.
- ⊙ If you do not want to continue drying, drying will stop if you press the stop button or leave the seat. There is a 5 second delay for the vent outlet before it fully shuts down automatically.

— Deodorizer —



Deo - button

- ⊙ The deodorizer should only run for at most three minutes when seated. It will stop immediately when you leave the seat. If you want to continue use, press the Deo - button again and the deodorizer will continue to run for another three minutes before stopping.
- ⊙ If you use rinsing, the deodorizing function will automatically run for one minute after you leave the seat.

### Energy Saving



- ⊙ The energy saving key may only be used when setting the temperature for the rinsing water or the warm seat.
- ⊙ When energy saving is activated, the water temperature or seat temperature will be set to a 30°C constant temperature standby mode and the energy saving lamp will remain lit up.
- ⊙ After the person sits down, the temperature will automatically rise to the original temperature and the energy saving lamp will flash.
- ⊙ When the person leaves the seat, the water temperature and seat temperature will return back to the 30°C constant temperature standby mode.

### Night Light



- ⊙ When the unit is plugged into a power source, the factory setting of the night light is set to stay-on mode.
- ⊙ Press the night light button to cycle between the three modes (see Fig below).

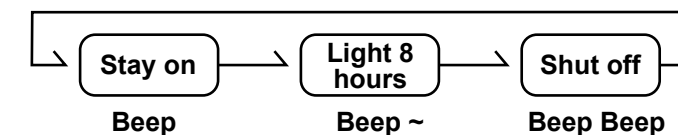

# How to Use Correctly

## Sit

### Heated Seat

Sit on toilet

## Cleansing

### WASH Function



Press WASH  
Then press again  
to activate spa  
function

### BIDET Function



Press BIDET  
Then press again  
to activate spa  
function

### Seat Temp. adjustment



Press seat  
temp. button  
Select suitable  
temperature

### Water Temp. adjustment



Press the water  
temp. key to  
select a suitable  
temperature

### Water Flow



Press water flow adjustment  
button to adjust water flow  
strength to a suitable level

- ⊙ If not much water is flowing out of the nozzle, adjust to water flow to strong
- ⊙ Lamp on the far right side Flushing water needs time to heat up from room temperature to a high temperature  
Give enough time for heating so it can reach the temperature you want

## Before operation

- ① Check if the tap water shutoff valve is open or not. If closed, open in a counterclockwise direction towards the toilet tank

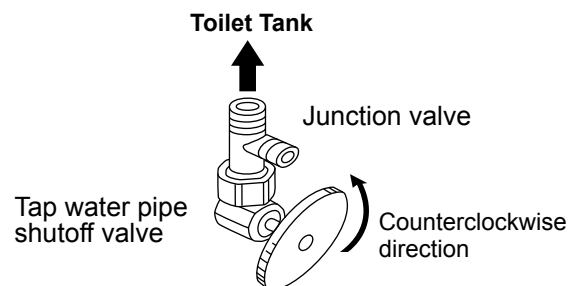

- ② Plug the power source into the socket with the correct rated voltage and the power indicator will light up.

## How to use correctly

- ⊙ After pressing any button on the control panel, the lamp will light up continuously for five seconds
- ⊙ When the remote control is running out of power, the power lamp will flash for 30 sec to remind you to promptly replace the batteries.
- ⊙ Bidet, cleansing and dryer functions are only activated after you sit down.
- ⊙ The water temperature and seat temperature can be set according to your personal preference and adjustment can be divided into four stages.
- ⊙ Use the stop button to stop rinsing and dryer.
- ⊙ The microcomputer circuits will still consume a small amount of power when the unit is the no heating mode so unplug the power and drain the water out of the water tank when not in use for a long period of time.

# Use Instructions



**Unplug the power to the unit during lightning storms.**  
-A malfunction could happen if not unplugged.

**Do not remove the water filter if the shut-off valve is not closed.**  
-Otherwise water will spray out.

**Do not install the unit on a base plate before installing the unit on the toilet.**  
-When installed this way, the unit could burn out when connected to the power source.

# Part Description

